

9th Slide Set Computer Networks

Prof. Dr. Christian Baun

Frankfurt University of Applied Sciences
(1971–2014: Fachhochschule Frankfurt am Main)
Faculty of Computer Science and Engineering
christianbaun@fb2.fra-uas.de

Transport Layer

- Functions of the Transport Layer
 - Contains **end-to-end protocols** for inter-process communication
 - In this layer, processes are addressed via **port numbers**
 - Application Layer data is split here into smaller parts **segments**

TCP/IP Reference Model

Hybrid Reference Model

OSI Reference Model

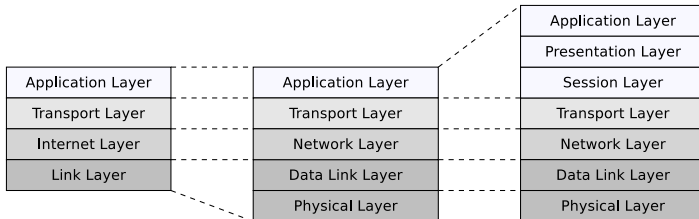

Exercise sheet 5 repeats the contents of this slide set which are relevant for these learning objectives

- Devices: Gateway
- Protocols: TCP, UDP

Characteristics of Transport Layer Protocols

- Desired characteristics of Transport Layer protocols include. . .
 - guaranteed data transmission
 - ensuring the correct delivery order
 - support for data transmissions of any size
 - the sender must not overload the network
 - It must be able to adjust its own data flow (data rate) \implies flow control
 - the receiver should be able to control the transmission rate of the sender \implies congestion control
- Transport Layer protocols are required which convert the networks' negative characteristics into the (positive) characteristics that are expected of Transport Layer protocols
- The most common used Transport Layer protocols:
 - **UDP**
 - **TCP**
- The addressing is realized via **sockets**

Ports (2/2)

- The port numbers are divided into 3 groups:
 - 0 to 1023 (*Well Known Ports*)
 - These are permanently assigned to applications and commonly known
 - 1024 to 49151 (*Registered Ports*)
 - Application developers can register port numbers in this range for own applications
 - 49152 to 65535 (*Private Ports*)
 - These port numbers are not registered and can be used freely
- Different applications can use identical port numbers inside an operating system at the same time, if they communicate via different transport protocols
- In addition, some applications exist, which implement communication via TCP and UDP via a single port number
- Example: Domain Name System – DNS (see slide set 10)
-
- Well Known Ports and Registered Ports are assigned by the Internet Assigned Numbers Authority (IANA)
 - In Linux/UNIX systems, the configuration file `/etc/services` exists
 - Here, the applications (services) are mapped to specific port numbers
 - In Windows systems: `%WINDIR%\system32\drivers\etc\services`

User Datagram Protocol (UDP)

- **Connectionless Transport Layer protocol**
 - Transmissions take place without previous connection establishment
- More simple protocol in contrast to the connection-oriented TCP
 - Only responsible for addressing of the segments
 - Does not secure the data transmission
- The receiver does not acknowledge transmissions at the sender
 - Segments can get lost during transmission
- Depending on the application (e.g. video streaming) this is accepted
 - If a TCP segment (and therefore some image information) gets lost during the transmission of a video, it is requested again
 - A drawback would be dropouts
 - To compensate for this, a buffer at the receiver site is required
 - Especially video telephony software tries to keep the buffer as small as possible because they cause delays
 - If UDP is used for video transmission or video telephony, the only consequence of losing a segment is losing an image

Sockets via UDP – Example (Server)

```

1  #!/usr/bin/env python
2  # Server: Receives a message via UDP
3
4  import socket          # Import module socket
5
6  # For all interfaces of the host
7  HOST = ''              # '' = all interfaces
8  PORT = 50000           # Port number of server
9
10 # Create socket and return socket descriptor
11 sd = socket.socket(socket.AF_INET, socket.SOCK_DGRAM)
12
13 try:
14     sd.bind((HOST, PORT)) # Bind socket to port
15     while True:
16         # Receive data
17         data = sd.recvfrom(1024)
18         # Print out received data
19         print 'Received:', repr(data)
20 finally:
21     sd.close()           # Close socket

```

```
$ python udp_server.py
```

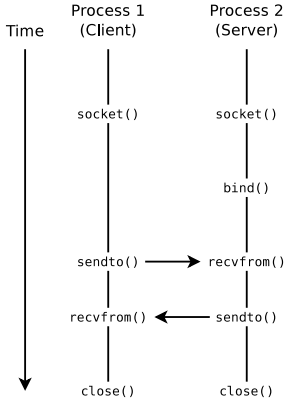

Structure of TCP Segments (2/5)

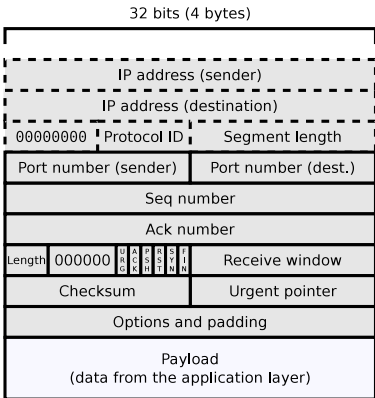

- One field contains the port number of the sender process
- Another field contains the port number of the process which is expected to receive the segment
- **Seq number** contains the sequence number of the current segment
- **Ack number** contains the sequence number of the next expected segment

- The **length** field specifies the size of the TCP header in 32-bit words to tell the receiver where the payload starts in the segment
 - The field is required, because the field *options and padding* can have a variable length (a multiple of 32 bits)

Structure of TCP Segments (3/5)

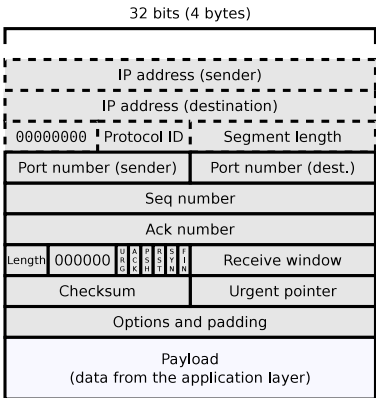

- The field 000000 is 6 bits long and not used
 - It contains per default value zero
- The 6 fields with a size of 1 bit each are required for connection establishment, data exchange and connection termination
 - The functionality of these fields is described with the assumption that the fiels contain the value 1 ⇒ it is set

URG (Urgent) is not discussed in this course

- **ACK** (Acknowledge)
 - Specifies that the acknowledgement number in **Ack number** is valid
 - It is also used to acknowledge the receive of segments

Structure of TCP Segments (4/5)

32 bits (4 bytes)

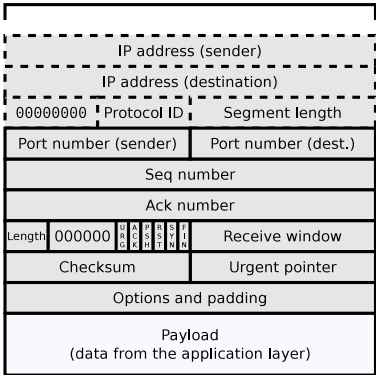

PSH (Push) is not discussed in this course

RST (Reset) is not discussed in this course

- **SYN** (Synchronize)
 - Requests the synchronization of the sequence numbers
 - That initiates the connection establishment
- **FIN** (Finish)
 - Requests the connection termination and indicates that the sender will not send any more payload

- The field **receive window** contains the number of free bytes in the sender’s receive window, which is necessary for flow control

Structure of TCP Segments (5/5)

32 bits (4 bytes)

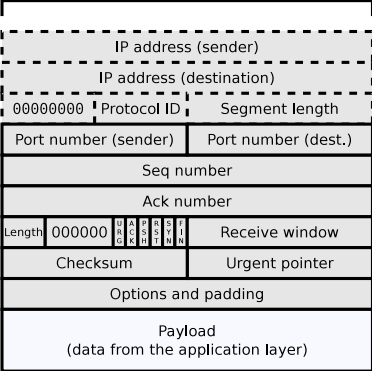

- Just as with UDP, for each TCP segment, a pseudo header exists, which is not transmitted
- But the pseudo header fields are used together with the regular TCP header fields and the payload to calculate the **checksum**
- **Protocol ID** of TCP = 6

The **urgent pointer** is not discussed in this course

The field **options and padding** must be a multiple of 32 bits and is not discussed in this course

Remember NAT from slide set 8...

If a NAT device (Router) is used, this routing device also needs to recalculate the checksums in TCP segments when doing IP address translations

Functioning of TCP

You already know...

- Each segment has a unique **sequence number**
- The sequence number of a segment is the position of the segment's first byte in the data stream

- The sequence number enables the receiver to...
 - correct the order of the segments
 - sort out segments, which arrived twice
- The length of a segment is known from the IP header
 - This way, missing bytes in the data stream are discovered and the receiver can request lost segments
- To establish a connection, TCP uses a **three-way handshake**, where both communication partners exchange control information in three steps
 - This ensures that the communication partner exists and data transmissions are accepted

TCP Connection Establishment (three-way Handshake)

- The server waits passively for an incoming connection
- ① Client sends a segment with $SYN=1$ as a request to synchronize the sequence numbers
⇒ *Synchronize*
- ② Server sends as confirmation a segment with $ACK=1$ and requests with $SYN=1$ to synchronize the sequence numbers too
⇒ *Synchronize Acknowledge*
- ③ Client confirms with a segment with $ACK=1$ that the connection is established
⇒ *Acknowledge*
- The initial sequence numbers (x and y) are determined randomly
- No payload is exchanged during connection establishment!

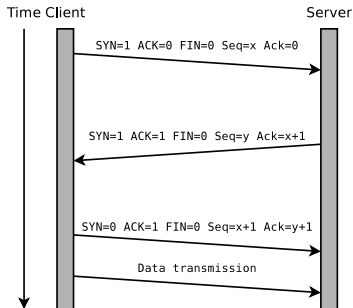

TCP Data Transmission

To demonstrate a data transmission, **Seq number** (sequence number of the current segment) and **Ack number** (sequence number of the expected next segment) need particular values

- In our example at the beginning of the three-way handshake, the client's sequence number is $x=100$ and the server's sequence number is $y=500$
- After completion of the three-way handshake: $x=101$ and $y=501$

- 1 The client transmits 1000 bytes payload
- 2 Server acknowledges with $ACK=1$ the received payload and requests with the Ack number 1101 the next segment. In the same segment, the server transfers 400 bytes of payload
- 3 The client transmits another 1000 bytes payload. And it acknowledges the received payload with the ACK bit set and requests with the Ack number 901 the next segment
- 4 Server acknowledges with $ACK=1$ the received payload and requests with the Ack number 2101 the next segment

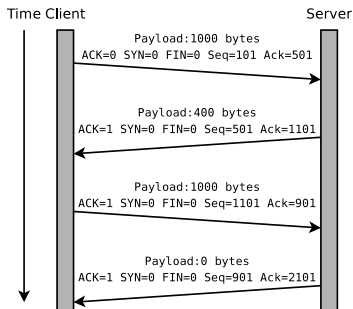

TCP Connection Termination

- Connection termination is similar to the connection establishment
- Instead of the SYN bit set, the FIN bit is used to indicate that the sender will not transmit any more payload

- 1 The client sends the request for connection termination with $FIN=1$
- 2 The server sends an acknowledgment with $ACK=1$
- 3 The server sends the request for connection termination with $FIN=1$
- 4 The client sends an acknowledgment with $ACK=1$

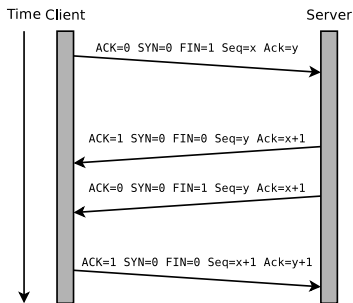

- No payload is exchanged during connection termination!

Reliable Transmission through Flow Control

- Via Flow control, the receiver controls the **transmission speed** of the sender dynamically, and this way ensures the **completeness of the data transmission**
 - Receivers with a low performance should not be flooded with data they can not process fast enough
 - As result, data would be lost
 - During transmission, lost data is transmitted again
- Procedure: **Transmission retries**, when they are required
- Basic mechanisms:
 - **Acknowledgements** (ACK) as feedback (receipt)
 - **Timeouts**
- Concepts for flow control:
 - **Stop-and-Wait**
 - **Sliding Window**

Stop-and-Wait

- After transmitting a segment, the sender waits for an ACK
 - If no ACK arrives in a certain time \Rightarrow timeout
 - Timeout \Rightarrow segment is sent again

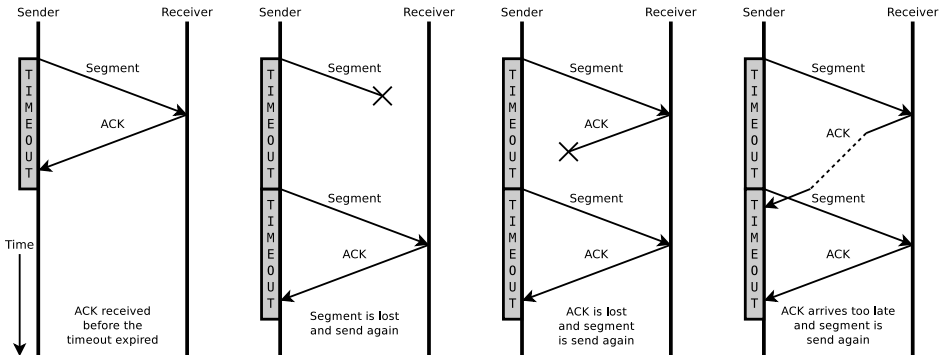

- Drawback: Lesser throughput compared to the transmission-line capacitance

The **Trivial File Transfer Protocol** (RFC 783) operates according to the Stop-and-Wait principle

Sliding Window

- A **window** allows the sender to transmit a certain number of segments before an acknowledgment is expected
 - Upon arrival of an acknowledgment, the transmit window is moved, and the sender can send further segments
 - The receiver can acknowledge several segments at once
⇒ **cumulative acknowledgments**
 - If a timeout occurs, the sender transmits all segments in the window again
 - The sender sends everything again beginning from the last not acknowledged sequence number
- Objective: Better utilization of the line capacity and receiver capacity

Sliding Window – Method: Sender

- The transmit buffer contains data of the Application Layer, which...
 - has already been sent but not yet confirmed
 - is ready to be send, but has not been send up to now

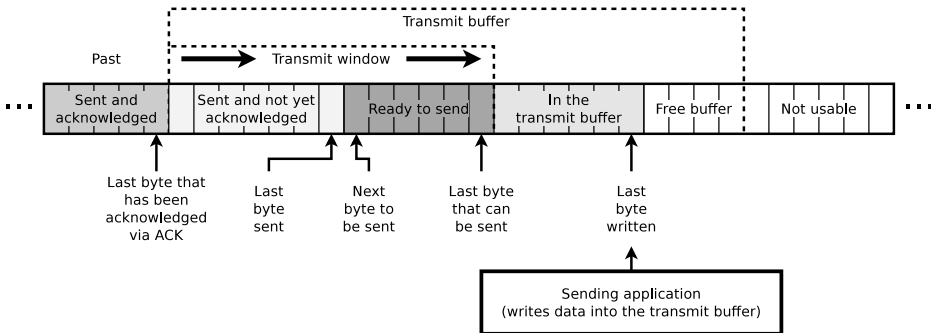

Sliding Window – Method: Receiver

- The receive buffer contains data for the Application Layer, which...
 - is in the correct order, but has not been read
 - has been received out of sequence

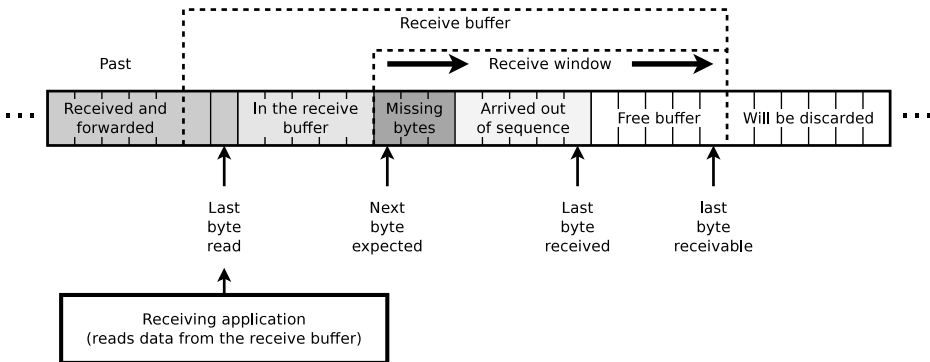

- The receiver informs the sender about the size of its receive window
 - This is important to avoid a buffer overflow!

TCP Flow Control

Segment to be sent

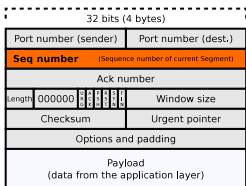

Received segment

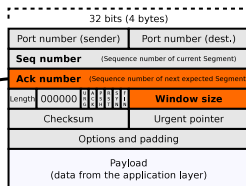

Receiver informs about the number of bytes it is able to receive

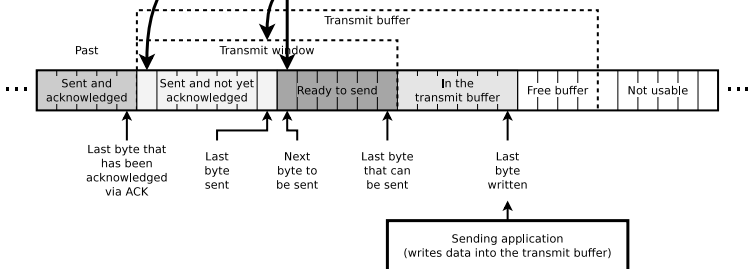

Example of Flow Control in TCP

- The receiver informs the sender in every segment how much free storage capacity its receive window has
- If the receive window has no free capacity, the sender is blocked until it gets informed by the receiver that free storage capacity exists
- If storage capacity in the receive window becomes free \implies **A segment with the current free storage capacity is sent**

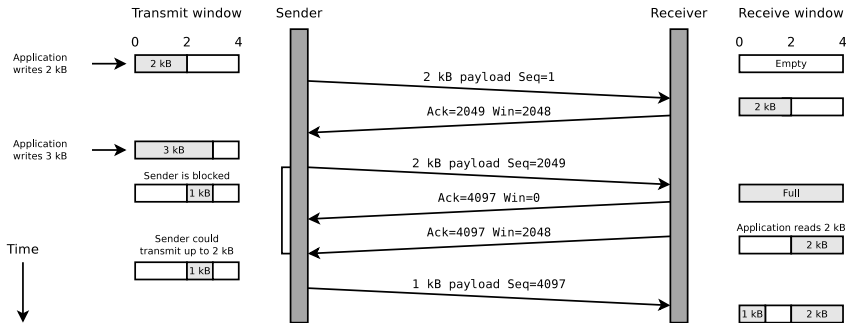

Silly Window Syndrome

- The **Silly window syndrome** is a problem where a large number of segments is sent, which increases the protocol overhead
 - Scenario
 - A receiver is overloaded and its receive buffer is completely filled
 - Once the application has read a few bytes (e.g. 1 byte) from the receive buffer, the receiver sends a segment with the free storage capacity of the receive buffer
 - For this reason, the sender transmits a segment, which contains just 1 byte payload
 - Overhead: At least 40 bytes for the TCP/IP headers of each IP packet (Required are: 1 segment with the payload, 1 segment for the acknowledgement and eventually another segment which notifies about the current free storage capacity in the receive window)
 - Solution: **Silly window syndrome avoidance**
 - The receiver notifies the sender about free storage capacity in the receive window not before 25% of the receive buffer is free or a segment of size MSS can be received

Reasons why Congestion occurs

- Possible reasons for the occurrence of congestion:
 - ① **Receiver capacity**
 - The receiver can not process the received data fast enough and therefore its receive buffer becomes full
 - Already solved by **flow control**
 - ② **Network capacity**
 - Congestion (overload) occurs when the utilization of a computer network exceeds its capacity \implies **congestion control**
 - Only useful reaction to congestion: **Reduce the data rate**
 - TCP tries to avoid congestion by changing the window size dynamically \implies **dynamic sliding window**
- *The one solution*, which solves both causes does not exist
 - Both causes are addressed separately

Signs of congestion of the network

- Packet losses due to buffer overflows in Routers
- Long waiting times due to full queues in Routers
- Frequent retransmissions due to timeout or packet-/segment loss

Approach to avoid Congestion

- The sender maintains 2 windows
 - ① **Advertised Receive Window**
 - Avoids congestion of the receiver
 - Offered (*advertised*) by the receiver
 - ② **Congestion Window**
 - Avoids congestion of the network
 - Determined by the sender
- The minimum of both windows is the maximum number of bytes, the sender can transmit
 - Example:
 - If the receive window of the receiver has a free storage capacity of 20 kB, but the sender recognizes that a network congestion occurs when more than 12 kB are sent, it transmits only 12 kB

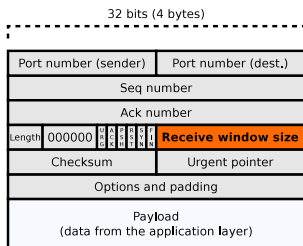

• How does the sender know the capacitance of the network?
 ⇒ how does the sender determine the size of the congestion window?

Determine the Size of the Congestion Window

You already know...

- The sender can exactly specify the size of the receive window
 - Reason: The receiver informs the sender with every segment, about the free storage capacity of its receive window
-
- Challenge for the sender: **What is the size of the congestion window?**
 - The sender never knows for sure the capacity of the network
 - The capacity of computers networks is not static
 - It depends among others of the network utilization and of the occurrence of network faults
 - Solution: The sender must **incrementally** try to identify the network capacity

Determine the Congestion Window Size – Connection Establishment

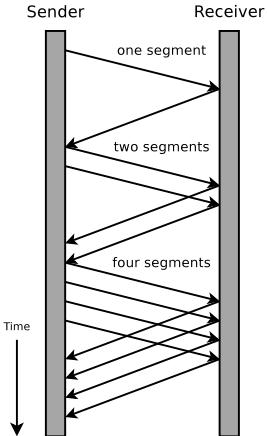

- During connection establishment, the sender initializes the congestion window to maximum segment size (MSS)
- Method:
 - 1 segment of size MSS is sent
 - If the segment is acknowledged before the timeout expires, the congestion window is doubled
 - 2 segments of size MSS are sent
 - If both segments are acknowledged before the timeout expires, the congestion window is doubled again
 - ...

Determine the Congestion Window Size – Slow Start

Congestion Window [kB]

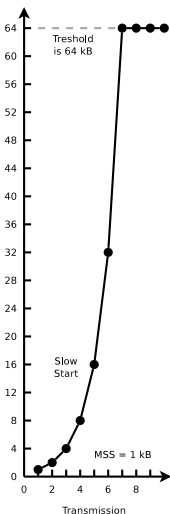

- The congestion window grows exponentially until...
 - the size of the receive window is reached, which has been determined by the sender
 - or the **threshold** is reached
 - or a **timeout** expires
- The exponential growth phase is called **slow start**
 - Reason: The low transmission rate of the sender at the beginning
- If the congestion window reaches the size of the receive window, it stops growing
- At the beginning of the transmission, the threshold value is 2^{16} bytes = 64 kB, so that it plays no role at the beginning
 - Maximum size of the receive window: $2^{16} - 1$ bytes
 - This is determined by the size of the field **window size** in the TCP header

Determine the Congestion Window Size – Congestion Avoidance

Congestion Window [kB]

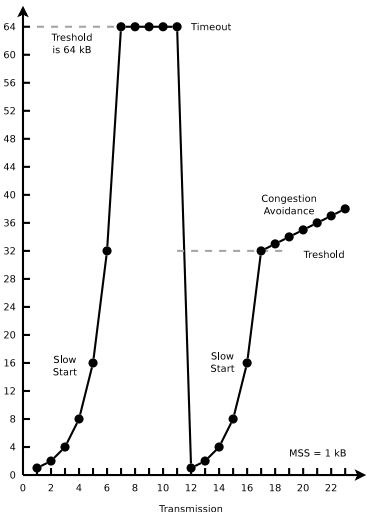

- If a timeout expires, . . .
 - the threshold value is set to the half congestion window
 - and the size of the congestion window is reduced to the size 1 MSS
- Then, once again the slow start phase follows
 - If the threshold value is reached, the congestion window grows linear, . . .
 - until the size of the receive window is reached, which is determined by the receiver
 - or until a timeout expires
- The linear growth phase is called **congestion avoidance**

Possible Continuation of the Example

Congestion Window [kB]

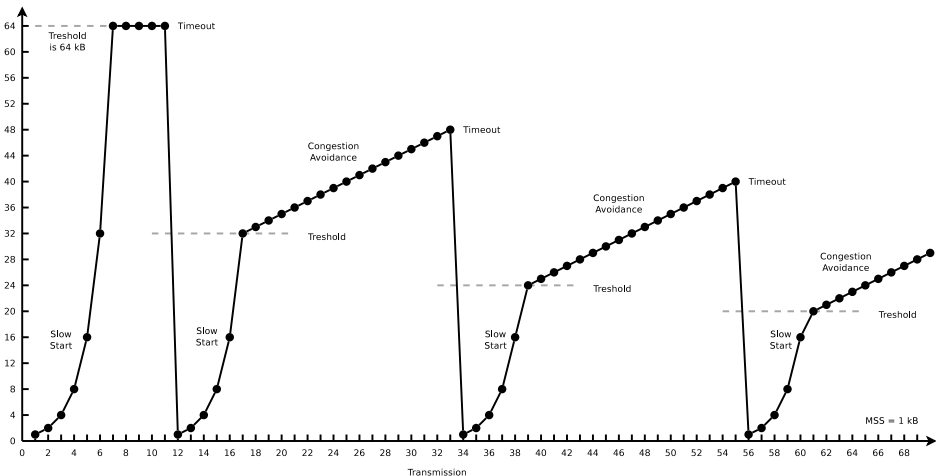

Reasons why a Timeout expires and reasonable Proceeding

- An expired **timeout** can have different reasons
 - Congestion (\implies delay)
 - Loss of a transmission
 - Loss of an acknowledgment (ACK)
- Not only delays due to congestion, but also each loss event reduces the congestion window to size 1 MSS
 - This way works the obsolete TCP version *Tahoe* (1988)
- Modern TCP versions differ between. . .
 - expired timeout caused by congestion of the network
 - and **multiple arrival of acknowledgments** (ACKs) caused by loss event

Fast Retransmit

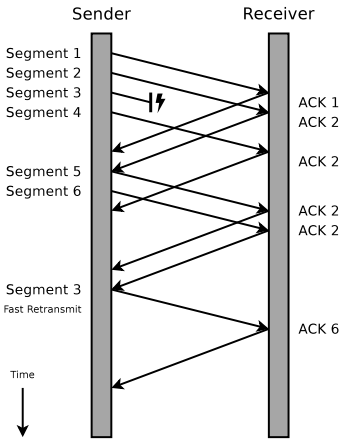

- A lost segment causes a *gap* in the data stream at receiver site
 - The receiver sends for every additional received segment an ACK for the segment before (the lost segment!)
- If a segment gets lost, a reduction of the congestion window to value 1 MSS is not necessary
 - Reason: A segment loss is not caused by congestion in any case
- **If 3 duplicate ACKs arrive, TCP Reno (1990) sends the lost segment again**
 ⇒ **fast retransmit**

Fast Recovery

Congestion Window [kB]

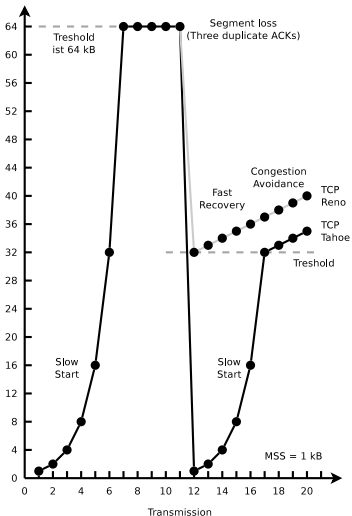

- TCP *Reno* also avoids the slow start phase if 3 duplicate ACKs arrive
 ⇒ **fast recovery**
- If 3 duplicate ACKs arrive, the congestion window is set directly to the threshold value
 - The congestion window grows linear with every acknowledged transmission, . . .
 - until the size of the receive window is reached, which is specified by the receiver
 - or until a timeout expires

Additive Increase / Multiplicative Decrease (AIMD)

- The concept of TCP congestion control is called AIMD
 - It stands for **rapid reduction** of the congestion window after a timeout expired or a loss event occurred and **slow (linear) increase** of the congestion window
- Reason for **aggressive reduction** and **conservative increase** of the congestion window:
 - The consequences of a congestion window which is too large in size are worse than for a window which is too small
 - If the window is too small in size, available bandwidth remains unused
 - If the window is too large in size, segments will get lost and must be transmitted again
 - This increases the congestion of the network even more!
- The state of congestion must be left as quick as possible
 - Therefore, the size of the congestion window is reduced significantly

Summary of Flow Control and Congestion Control

- By using **flow control**, TCP tries to use the available bandwidth of a connectionless network (\implies IP) efficiently
 - Sliding windows at sender site (**transmit window**) and receiver site (**receive window**) are used as buffers for sending and receiving
 - The receiver controls the transmission behavior of the sender
- Reasons why congestion happens: **receiver capacity** and **network capacity**
 - The receive window avoids congestion of the receiver
 - The congestion window avoids congestion of the network
 - Actual available (used) window = minimum of both windows
- Attempt to maximize the network utilization and react rapidly to indications for congestion
 - Principle of **Additive Increase / Multiplicative Decrease** (AIMD)

Connection-oriented Communication via Sockets – TCP

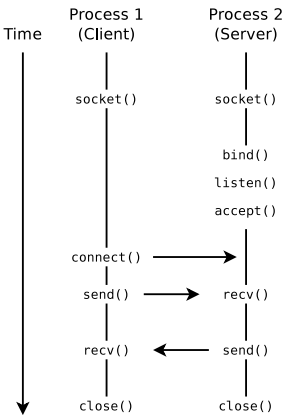

● Client

- Create socket (socket)
- Connect client with server socket (connect)
- Send (send) and receive data (rcv)
- Close socket (close)

● Server

- Create socket (socket)
- Bind socket to a port (bind)
- Make socket ready to receive (listen)
 - Set up a queue for connections with clients
- Server accepts connections (accept)
- Send (send) and receive data (rcv)
- Close socket (close)

Sockets via TCP – Example (Server)

```
1 #!/usr/bin/env python
2 # Echo Server via TCP
3 import socket                # Import module socket
4
5 HOST = ''                    # '' = all interfaces
6 PORT = 50007                 # Port number of server
7
8 # Create socket and return socket descriptor
9 sd = socket.socket(socket.AF_INET, socket.SOCK_STREAM)
10 # Bind socket to port
11 sd.bind((HOST, PORT))
12 # Make socket ready to receive
13 # Max. number of connections = 1
14 sd.listen(1)
15 # Socket accepts connections
16 conn, addr = sd.accept()
17
18 print 'Connected by', addr
19
20 while 1:                     # Infinite loop
21     data = conn.recv(1024)   # Receive data
22     if not data: break       # Break infinite loop
23     conn.send(data)         # Send back received data
24
25 sd.close()                   # Close socket
```

```
$ python tcp_server.py
```

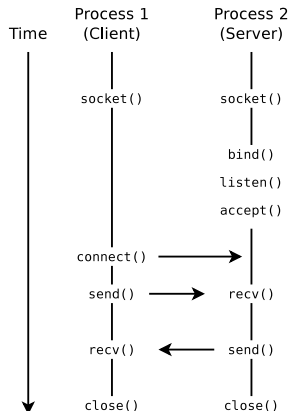

Sockets via TCP – Example (Client)

```

1  #!/usr/bin/env python
2  # Echo Client via TCP
3
4  import socket                # Import module socket
5
6  HOST = 'localhost'          # Hostname of Server
7  PORT = 50007                # Port number of server
8
9  # Create socket and return socket descriptor
10 sd = socket.socket(socket.AF_INET, socket.SOCK_STREAM)
11 # Connect with server socket
12 sd.connect((HOST, PORT))
13
14 sd.send('Hello, world')      # Send data
15 data = sd.recv(1024)         # Receive data
16 sd.close()                   # Close socket
17
18 # Print out received data
19 print 'Empfangen:', repr(data)

```

```
$ python tcp_client.py
Empfangen: 'Hello, world'
```

```
$ python tcp_server.py
Connected by ('127.0.0.1', 49898)
```

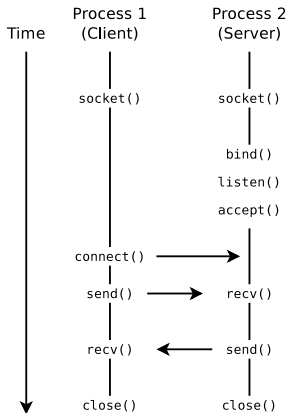

Denial-of-Service Attacks via SYN Flood

- Target: Making services or servers inaccessible
- A client sends multiple connection requests (**SYN**), but does not respond to the acknowledgments (**SYN ACK**) of the server via **ACK**
- The server waits some time for the acknowledgment of the client
 - The confirmation delay could be caused by a network issue
 - During this period, the address of the client and the status of incomplete connection are stored in the memory of the network stack
- By flooding the server with connection requests, the table, which stores the TCP connections in the network stack is completely filled
⇒ the server gets unable to establish new connections
- The memory consumption at the server may become this large that the main memory gets completely filled and the server crashes
- Countermeasure: Real-time analysis of the network by intelligent firewalls